

ST PETER'S CHURCH, CHILLINGHAM

AN ARCHAEOLOGICAL ASSESSMENT

APRIL 2019



The church seen from the south-west

PETER F RYDER
B.A., M.Phil, F.S.A
HISTORIC BUILDINGS CONSULTANT

The Vicarage
Otterburn
Newcastle upon Tyne
NE19 1NP
01830 520590
E mail: PFRyder@broomlee.org



St Peter's Church, Chillingham

The village of Chillingham, best known for its medieval castle (and herd of white cattle) lies c 6 km east of Wooler, on the east side of the broad valley of the Till. The church stands c 100 m north of the Castle, and is built on a considerable slope (dropping from east to west). It consists of an aisleless nave with a south porch, and a chancel with a large south-west chapel and a smaller addition here termed the North-West Pew.



Location Map

Ordnance Survey Landranger 1:50,000 sheet 75
Ordnance Survey map licence 100045703

The building is constructed of coursed stone of a variety of types; the low-pitched roof of the nave, concealed behind the parapets, may be of lead, but those of the remainder of the building are of graduated stone flags.

The **Nave** is built of coursed squared stone, with some very large blocks in the lower parts of the side walls where the coursing is parallel to the ground rather than horizontal. The lower part of the west end has less massive courses and more thinly-coursed stone above.

The west end has a substantial buttress at each end, with a sloping top, the southern rather taller than the north; the northern has a chamfered plinth. Just above this the main west wall has a rough offset, hidden by rising ground as one proceeds south. The west window is probably of earlier 19th century date; it has a two-centred arch and a chamfered surround, in red sandstone ashlar, and white-painted wooden tracery forming two trefoil-headed lights with a pierced spandrel. Directly beneath the window Honeyman¹ may have been fanciful in seeing the lower jambs and sill of a much narrower opening. The wall has an irregular stepped coping, and a bellcote, in tooled squared stone, which has a tall square-headed opening under a pedimented gable.

¹ (1935) Northumberland County History XIV. 310-321

The western part of the south wall of the nave is covered by the South Porch; the wall has a chamfered offset c 0.6 m below the parapet, which has a chamfered coping and two square-headed openings at the head of drain pipes. East of the porch are two square-headed windows, each of two lights with depressed segmental heads; the western is of 19th century date and has a surround with alternating-block jambs, in red sandstone –the older eastern one is similar, but in greyer stone, and has what looks to be part of a medieval grave slab, with an incised cross shaft, re-used in its east jamb. Beneath this window is the outline (also clearly visible internally) of an earlier blocked window, c 0.60 m square, but lacking its head.



The north wall of the nave (above) has a chamfered plinth that slopes down even more steeply than the ground surface, so as to disappear half way along the wall – a short length of chamfer at the west end relates to the added north-west buttress. There are some especially large blocks immediately above the plinth, with a huge one at the east end that has a rough arched cutout in its lower edge, part of a blocked opening that cuts through the plinth below. A couple of courses above this two adjacent L-shaped blocks suggest the base of a window, and a little higher still is what looks like a narrow infilled vertical slot. Some or all of these features must relate to a former heating chamber set in the angle between the nave and the North-West Pew². There is also a chamfered off-set which on this side is c 3 m above the ground , again following the slope of the ground. The only

² A 'Stoke Hole' is shown here on the 1870 plan by F.R.Wilson, Churches of the Archdeaconry of Lindisfarne, f.p.70, and a Heating Chamber on Honeyman's 1935 plan.

architectural feature in the wall below is the blocked north door, towards the west end of the wall; this has a chamfered two-centred arch, with its head formed from two blocks. In the upper part of the wall there is a single two-light window near the east end, with depressed segmental arches to its lights, very similar to the two windows in the south wall.

The **South Porch** is built of roughly-coursed and roughly-squared stone, with some blocks reddened as if by burning. The end wall has a chamfered plinth, returned on the jambs of its round-headed arch, which has a chamfered surround broken by impost blocks chamfered on their lower angles. The jambs look of some age (with some old incised graffiti) but the arch and gable are in more recent stone. Above the arch is a small ashlar panel, apparently blank, with a gabled top, and the gable which has a coping chamfered on its underside. The side walls are plain.

The western parts of the side walls of the **Chancel** are concealed by adjacent structures. The south side of the eastern bay is largely of coursed squared stone, but is a multi-phase fabric with considerable signs of disturbance. There is a single small window set low, which has the feel of being made up of re-used material; it has an almost triangular head cut from a pair of stones, and a chamfered surround.



The church from the north-west, with steps down to crypt.

The east end has a single large square-headed window, simply glazed with no mullions or tracery; its lintel is roughly tooled, and its sill has a neat tooled-and-margined finish. At the level of the lintel a rough offset crosses the wall, its north end neatly chamfered, and its south ending just short of the south-east corner. The gable above is of more thinly-coursed stone, and looks rebuilt; it has a coping chamfered on its underside. Beneath the east window is a smaller square-headed opening, with vertical iron bars, lighting the crypt under the chancel.

The north wall of the chancel is of undisturbed coursed and squared blocks, some showing diagonal tooling; its only feature is a slight offset at plinth level, and at a lower level a 19th century doorway into the crypt, reached by a flight of steps between walls capped by cast-iron rails; it has a round arch, with rock-faced voussoirs.



The South Chapel, east wall.

The **South Chapel** is built of coursed squared stone, and has a steep-pitched roof with its eaves a little below those of the chancel although the two ridges are at the same height. At the north end of the west wall³ is a small blocked round-headed window in a chamfered surround, of 12th century character, apparently in an undisturbed area of walling of

³ See elevation p.13

squared blocks which would correlate with the same period. South-of-centre are remains of a larger lancet; its monolithic head and the uppermost stone of its north jamb survive, but the rest has been cut away by the 16th century (?) insertion of a round-arched doorway, with a continuous moulding of a roll between two hollows.

The south end of the chapel has a window of two trefoil-headed lights with a quatrefoil in the spandrel, under a double-chamfered two-centred arch, which looks authentically medieval. Above the outline of an older gable can be seen in the wall around a metre below the apex of the present one, which has a square-edged coping chamfered on its lower angle and a block finial.

The east side of the chapel has a window very like that on the south, set north-of-centre, with to the north of it and only c 0.30 m from the chancel wall a length of straight joint. Towards the south end of the wall is a smaller lancet, now blocked, with a monolithic head (like the now-fragmentary one opposite in the west wall). Higher up, just above the head of the larger window, is a moulded string course, now very worn.

The **North-West Pew** is built of squared and pecked stone, and has a shallow gable to the north and an oversailing course to the eaves. Its only opening is a two-light window in its north gable, very like that in the west end of the nave, in a slightly-raised stone surround. Its west wall has what looks like a column of later stone at its south end, which must relate to the former 'stoke hole' adjacent to the wall.⁴

Interior

The interior of the **South Porch** has stone benches, chamfered on their lower angle. These are probably of 19th century date, as is the scissor-braced roof. Over the south door is a tablet stating that the porch was restored by Rev Joseph Hudson in 1875.

The south door is of 12th century date, and has a slightly segmental round arch of two orders, the inner with a roll and two grooves, the outer chamfered, with a billet moulding to its extrados; old jamb shafts have cushion capitals, and impost blocks chamfered beneath. There is a segmental-headed inner arch which is probably of 19th century date.

Inside the building the walls are of exposed masonry, which is generally of the same character as that in the external walls, with very large blocks laid to the slope of the ground in the lower parts of the side walls of the nave.

⁴ Footnote 2 Was there ever a fireplace here to heat the Pew?

The south doorway has a 19th century segmental rear arch. There is a ragged vertical break in the fabric c 0.50 m from the west end of the wall, and an offset that is c 2 m below the eaves at the south-west corner, but then climbs to a higher level and passes over the head of the western of the two windows east of the porch, which has an almost flat rear arch of no great age; the eastern window has a shallow segmental rear arch that looks older, and both windows have steeply-sloping sills; below the eastern the internal jambs of the blocked window seen externally are clearly visible. Lower in the wall the massive squared blocks do not run its full length of the wall, but end about a metre short of the east end.

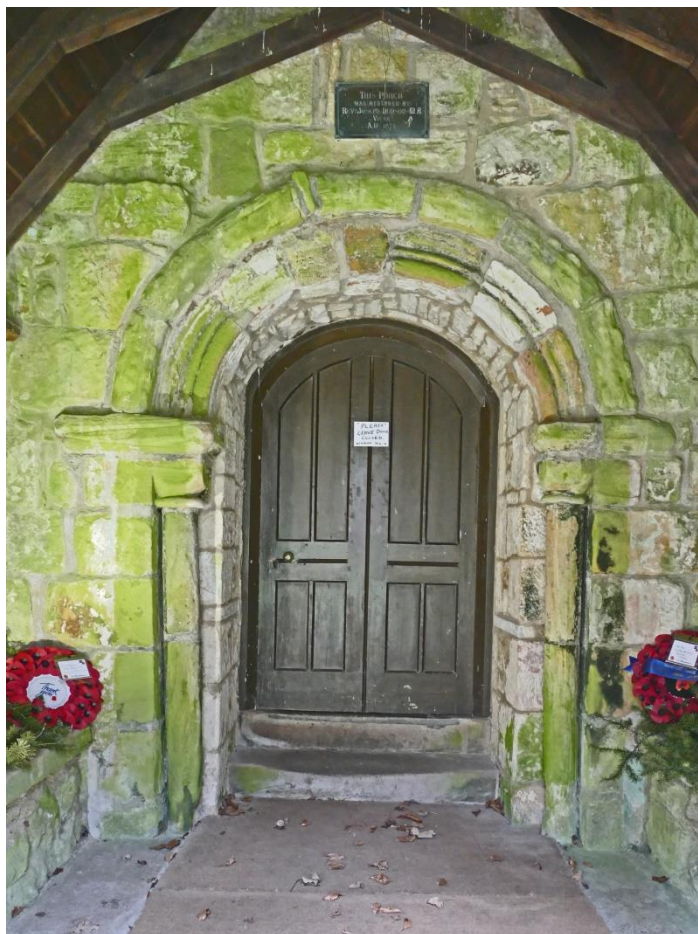

The South Doorway

The west wall of the nave is of quite heavy squared stone, but noticeably smaller and more regular than that in the side walls; the west window has a steeply-pointed rear arch in old brick; above it are the jambs of some sort of high level opening, either a taller window or possibly an opening relating to a previous bell cote. To the north of the window are a series of large infilled sockets, presumably relating to the early-19th century gallery.

The north wall of the nave again has quite dramatic massive sloping masonry in its lower part, and slightly smaller above. In the centre of the wall is a wall tablet to Robert Charnock d.1691 'late steward to Lord Grey'. The two-light window at the eastern end of the wall is very similar to that in the south wall opposite; below it what looks like a small trefoiled arch has been roughly cut into a large block, and later infilled; was this a piscina for an altar set against the north respond of the chancel arch?. The blocked north doorway has a square head internally, although this may be secondary.

The roof of the nave is of five bays, with trusses set against each end wall; the tie beams are carried on two-step corbels with a quadrant-shaped lower member; the roof is of very shallow pitch, with short king posts, a ridge and four levels of purlins.

The floor of the **Chancel** is set around a metre above that of the nave; in line with the west face of the chancel arch is a vertical wall, with in the centre a flight of five steps. The chancel arch is of segmental-pointed form and of two chamfered orders, both dying into plain square-section jambs of hammer-dressed stone; it is of pink sandstone, roughly pecked (to take plaster?) and appears entirely of 1829; above and to either side of it are shaped blocks which appear to have related to the extrados of its medieval predecessor.

At the west end of each side wall of the chancel is a very similar but broader arch, opening into the South Chapel and North-West Pew. The northern is of very similar stonework to the chancel arch but the southern is of more smoothly-tooled whiter stone, and might be medieval work (although it looks re-tooled); to the west of it only c 0.15 m from the corner of the chancel, is a straight joint, of uncertain significance. This southern arch is set back c 0.35 m outside the line of the inner face of the chancel wall further east; the north-western corner of its east respond has clearly been rebuilt in relatively recent fabric.

The internal wall faces of the three walls of the eastern section of the chancel are all of quite different fabric types. The south wall is the most complex. Between the rebuilt masonry of the eastern respond of the south arch and a straight joint c 0.50 m short of the 'low-side' window is a rough column, about a metre wide, of large squarish blocks, of 12th century character; higher up is much more rubbly masonry, but above that the fabric of the whole length of the wall seems homogenous. The small 'low side' window near the east end of the wall has a shouldered rear arch, its lintel set at a rather rakish angle on corbels which are re-used 12th-century stones (apparently from a string course, or perhaps an impost band) with a chamfer, groove and sunk star ornament; there is a third similar block in the wall immediately to the r. of the lintel and a fourth, set vertically, in the wall above. Higher up are the remains of the segmental rear arch of a larger window, not apparent externally, with a little to the west a small round-arched window head, perhaps of 12th century date, set upside down in the wall.

The lower part of the east wall, and the upper wall north of the window, are of regularly-coursed large squarish blocks, again of 12th-century character. The internal jambs of the east window are old in part, and have had broader splays, being roughly cut back to accommodate the present opening which has a shallow segmental rear arch of no great age. South of the window at the level of its sill (which is formed of chamfered blocks, perhaps re-used) is what looks like a cut-back corbel, and above that an odd straight joint with alternating blocks on its north side, almost as if it was the north jamb of a narrower window at the very end of the wall.

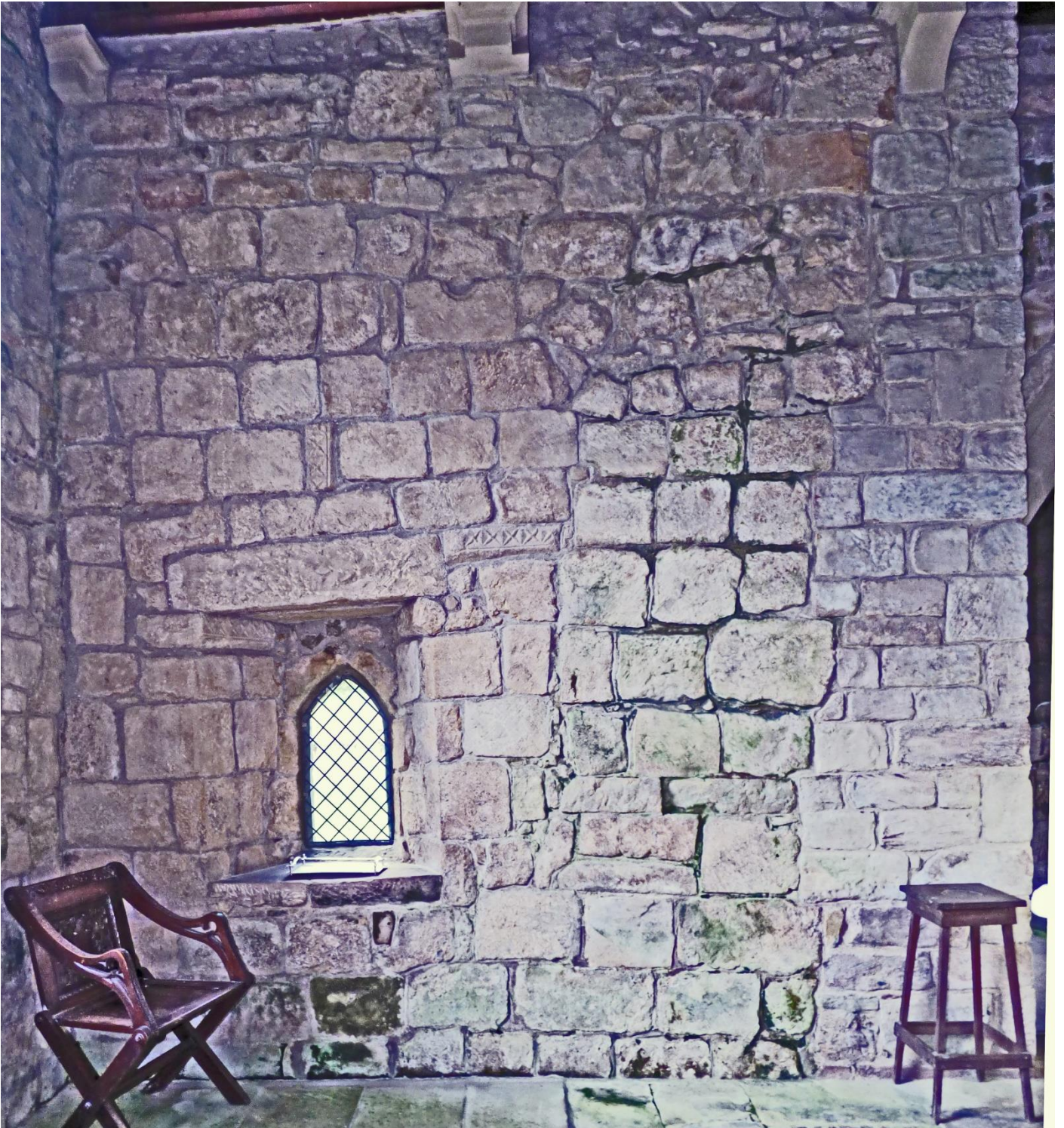

South wall of eastern bay of chancel, showing multi-phase fabric

The north wall of the chancel, to the east of the arch into the North Pew, is of regularly-coursed roughly-squared stone, and is featureless.

The chancel roof, much more steeply-pitched than that of the nave, is of five bays, with collared arch-braced trusses, a ridge and one level of purlins. All this is clearly of 19th century date and the ashlar corbels carrying its trusses might be even more recent.

The South Chapel

The South Chapel contains the spectacular tomb of c1450 of Sir Ralph Grey and his wife Elizabeth FitzHugh; this is arguably the most important medieval monument in Northumberland, but a detailed description of it is beyond the scope of this report⁵. The internal faces of all three walls of the chapel are of some structural complexity.

Beneath the broad arch into the chancel are two steps down to the lower floor of the chapel. The west wall has remains of the shouldered rear arches of two windows, the lower section of the southern cut away by the square-headed rear arch of the doorway, and the northern partly hidden by the adjacent tomb. The doorway has a chamfer only to its lintel; the north jamb look old but the south is in more recent coursed stone. The upper c 0.80 m of the wall, in more thinly-coursed fabric, is clearly a heightening.

On the south the two-light window has a chamfer only to its head; east of it is an ogee-arched piscina with a circular bowl in a semi-octagonal projection. A course above the head of the window is an infilled groove that looks to mark an old ceiling level, with in the centre of the wall just above it a big block with a socket c 0.30 m high and 0.10 m wide, presumably for a ceiling beam. Higher up the brick flue which rises from the fireplace in the south wall is carried up to the apex of the gable.

The east wall of the chapel has a chamfered rear arch to its two-light window, like that on the south, then further south is an attractive fireplace of late 18th or early 19th- century character, with an ashlar bolection-moulded surround and an inner metal frame with a cusped Gothick arch; behind the surround is a segmental relieving arch in brick, and above that the line of its inclined flue, faced in brick and with thin stone slabs forming its upper edge, rises diagonally up the wall to the south, cutting across the remains of the shoulder-headed rear arch of a lancet window, like the two in the west wall, within which is re-set a medieval cross slab. At each end of the wall, c 1.5 m above the floor, is a semi-octagonal ashlar corbel; if these are medieval they may have been re-cut.

⁵ The tomb and underlying vault are described and discussed by Heslop and Harbottle (1999) who also provide (p125) stone-by-stone elevations of both faces of the west wall of the chapel.



South Chapel, with Grey tomb, looking south-west

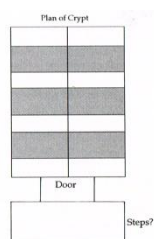

The chapel has a three-bay roof, of precisely the same character as that of the chancel.

Details of the vault beneath the tomb, and its (infilled) stepped approach from the east, are given by Heslop and Harbottle⁶.

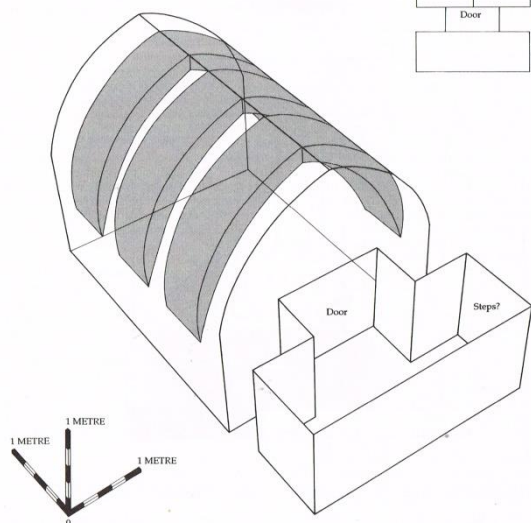

(left. Isometric drawing of crypt beneath Grey tomb. After Heslop & Harbottle 1999)

⁶ D.Heslop & B.Harbottle (1999) Chillingham Church, Northumberland: South Chapel and Grey Tomb ' *Archaeologia Aeliana* 5th series XXVII, 123-134).

In the shallow **North-West Pew** the window in the north wall has a rough rear arch with a chamfer to the head only. The internal wall faces of the chapel are in roughly-coursed rubble, in contrast to the squared stone of the exterior. The west wall has some medieval grave covers re-set in it, with above them a pair of straight joints. The southern is the north-east corner of the original nave, and the northern may relate to the putative removed flue here (see exterior description). The east wall has a horizontal break at c 1.5 m above the floor, with roughly-coursed rubble below and rather better quality roughly-squared stone above. The roof of the pew has a ridge board and ashlar to the eaves.

The Crypt

The crypt under the chancel, now only accessible through the late-19th century doorway on the north, is unfortunately fairly mute architecturally. The doorway (with an internal lintel of modern blockwork) enters it close to the east end of its north wall. It is a rectangular chamber 6.5 m long by 3.1 m wide, with a segmental barrel vault. Its walls and roof are all plastered, except at the east end where this has fallen and revealed coursed squared stone of rather indeterminate character. Concrete benches on three walls and two levels of burial spaces (only one occupied) at the west end all look fairly recent; behind this can be seen traces of what was presumably the original entry, at the south end of the west wall,

which must have been a descending stair from the south-west corner of the chancel, which has resulted in a small part of the vault being cut away. The only other opening is the window already described in the centre of the east end, the opening of which steps down through the thick wall to come in immediately below the vault.



The crypt beneath the chancel, looking west

The Structural History of the Church

There two principal sources that describe the architectural history of Chillingham church, the 1925 Northumberland County History account by H.L.Honeyman and the 1999 account by Heslop and Harbottle which concentrates on the South Chapel and Grey Tomb have already been cited⁷

Honeyman seems uncertain whether the nave walls may re- use Pre-Conquest material, and cites a possible re-used Anglian cross shaft in the north-west buttress⁸ of the nave and a grave slab now built into the west wall of the north chapel⁹ as other indicants of an early date. The megalithic masonry of the nave side walls certainly looks archaic, but on the north has a chamfered plinth with which it is clearly coeval, and which would be unusual before c1100 . The earliest architectural feature is the south doorway, of mid-12th century character. This is probably coeval with the fabric, as may have the responds of the former chancel arch shown on an 1809 watercolour (reproduced by Honeyman, f.p.317¹⁰).



Pencil drawing in church, based on Varley's 1809 watercolour

⁷ See footnotes 1 & 5

⁸ There seem no sign of it now.

⁹ Which could be of late 11th or 12th century date, although what he interprets as a Tau cross in fact seems to be the single-step base of a cross which has lost its upper end.

¹⁰ There is another view, apparently taken from a pencil drawing, at the west end of the nave, but this is not dated. It is so similar to the watercolour (only a human figure is in a different position) that one must be taken from the other

There is also squared stone work of 12th century type (although of more sophisticated character than that in the nave walls) in both the south wall of the chancel and the west wall of the South Chapel, although in both cases this might be re-used. The chancel seems somewhat elongate for an early Norman one; Morris¹¹ quotes a 1220 reference to Robert de Muschamp, giving the vicar of Chillingham as much as the best oak he wanted out of the great wood of Chillingham, for repairs to the church, and suggests that the chancel was extended at this time.

The west end of the nave, and its flanking buttresses, are of more regular and smaller stonework than the side walls, and there is a ragged joint west of the porch between the west end masonry and that of the side wall. Honeyman suggests that this rebuilding took place in ether 13th century.

*Elevations of West Wall of South Chapel
after Heslop & Harbottle 1999*

The South Chapel preserves evidence of a whole series of building phases. The side walls, with the remains of lancet windows that have shouldered rear arches, are largely of 13th century date, although the northern part of the west wall remains a conundrum. Externally it has masonry of 12th century character, which seems all of a piece with a small round-arched loop (making Honeyman read this as in situ 12th century walling, which seems reasonable) but internally the loop has a shouldered rear arch just like the two lancets – a real puzzle. Was the rear arch reconstructed in preparation for enlarging the outer opening into a lancet as well, but the task never completed? The larger two-light windows are later, from the end of the 13th or beginning of the 14th

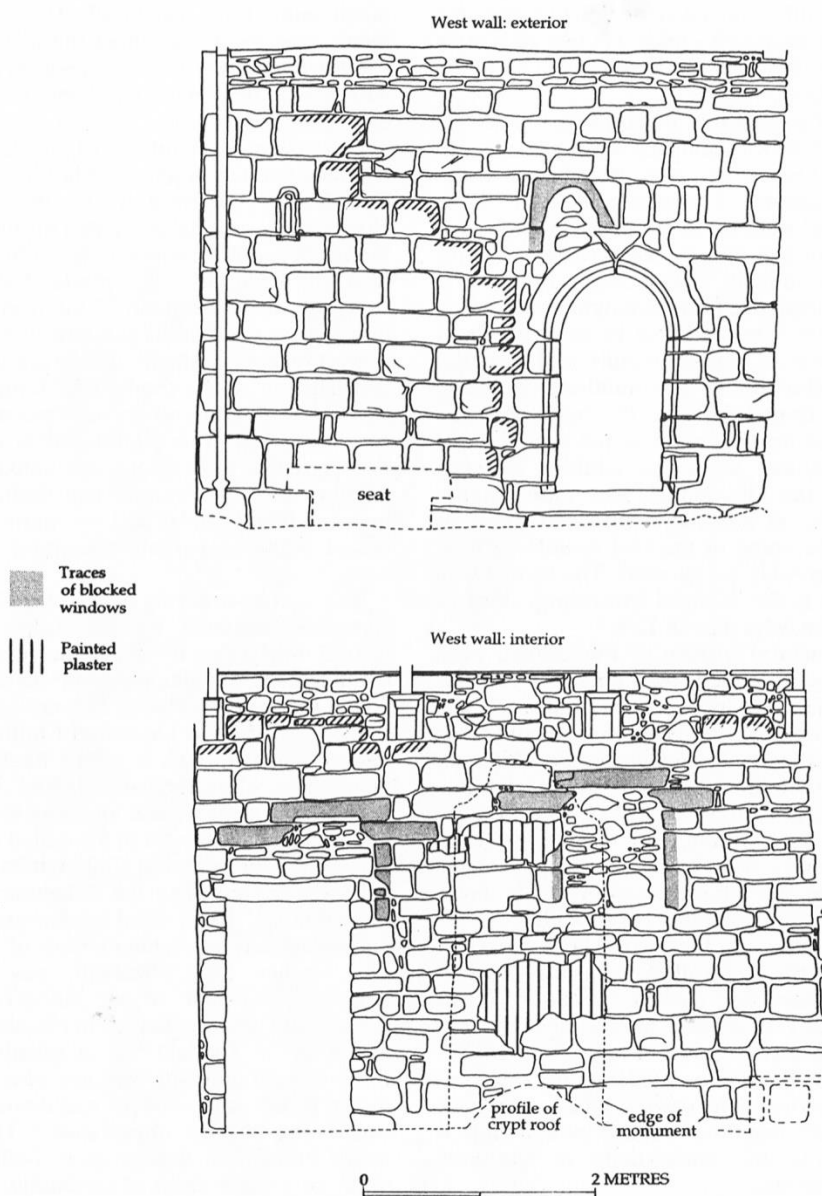

Chillingham Church: South Chapel, West Wall.

¹¹ Morris, J.E (*1916) *Northumberland* (Little Guide series, Methuen) 114

century; Honeyman thought the whole of the south end wall was rebuilt at this time as well, and the ogee arch of its piscina would tie in with this.

The construction of the spectacular Grey tomb is thought to correlate with another period of alterations. Honeyman thought that it was first placed in the choir (or under the arch between South Chapel and Choir) and then moved into its present position in the later 16th century, but the recent dismantling and restoration chronicled by Heslop and Harbottle revealed no clear evidence of a move. Honeyman saw the Chapel as being given a low-pitched roof and new parapets in the 14th or 15th century, whereas Heslop and Harbottle saw the walls being raised and the pitch of the roof increased when the monument was introduced. The external face of the south gable clearly shows that an earlier gable has been raised, but the stonework of the heightening looks of 19th century character.

Another late medieval change seems to have been the remodelling of the chancel arch, although we only have Varley's 1809 painting to go on, which shows a four-centred arch apparently of two chamfered orders, resting on 12th century responds and (on the south) an impost band.

Honeyman linked a 1589 request by Sir Thomas Grey to be buried 'within the tombe where other of my auncestors doo lye' with what he terms a 'drastic reconstruction' in which the walls of the nave were partly rebuilt and heightened. The eastern window in each side of the nave, and the round-arched doorway on the west of the South Chapel certainly look of late 16th century character. Perhaps the crypt under the chancel may be of the same date as well; when its present external doorway was created in the 19th century¹² the old entrance from inside the chancel had already been blocked up. Might this have been part of the Rev Joseph Hudson's works of 1875, when the south porch was partially rebuilt? Other relatively recent changes include the opening out and reconstruction of the small window on the south of the chancel¹³ and perhaps the opening out and restoration of the two-light window on the east side of the South Chapel¹⁴

As often, documentary references (quoted by Honeyman) assist with the dating of post-medieval changes. A new bell cote was provided (along with a new bell) in 1604, and both bell and cote replaced again in 1723. In 1829 there was a major restoration which Honeyman suggests was either carried out by the Windsor Castle architect Sir Jeffrey Wyattville or the more local John Green of Newcastle. This entailed the destruction of quite an amount of medieval work: the old chancel arch was replaced, and the North-West Pew, opening under a wide arch, added. Both new arches copy the arch into the South Chapel, which writers have been wary of dating (it was long covered by plaster) but which could be of 14th or 15th century date, albeit re-cut.

¹² It is not shown on Wilson's 1870 plan, and neither is any internal access

¹³ Which Morris, *op.cit.* in 1916 simply refers to as 'remains of a small blocked opening' and is not shown on Wilson's 1870 plan.

¹⁴ Also not shown on Wilson's plan

Varley's painting shows a four-light east window which Honeyman confidently interprets as having wooden tracery and being of 17th or 18th century date, although when he wrote it had been replaced by a 'modern' one that his plan shows to have had three lights. More recently, probably in the mid-20th century, its tracery has been removed, resulting in the present plain square-headed opening with plain glass, backing a modern cruciform metal screen. Opinions vary as to its aesthetic merit.

Other 20th century works, post-dating Honeyman's 1935 plan, include the removal of the Heating Chamber from the north side of the nave and the re-opening of the small window on the south side of the chancel.

ST PETER, CHILLINGHAM

Phased Plan

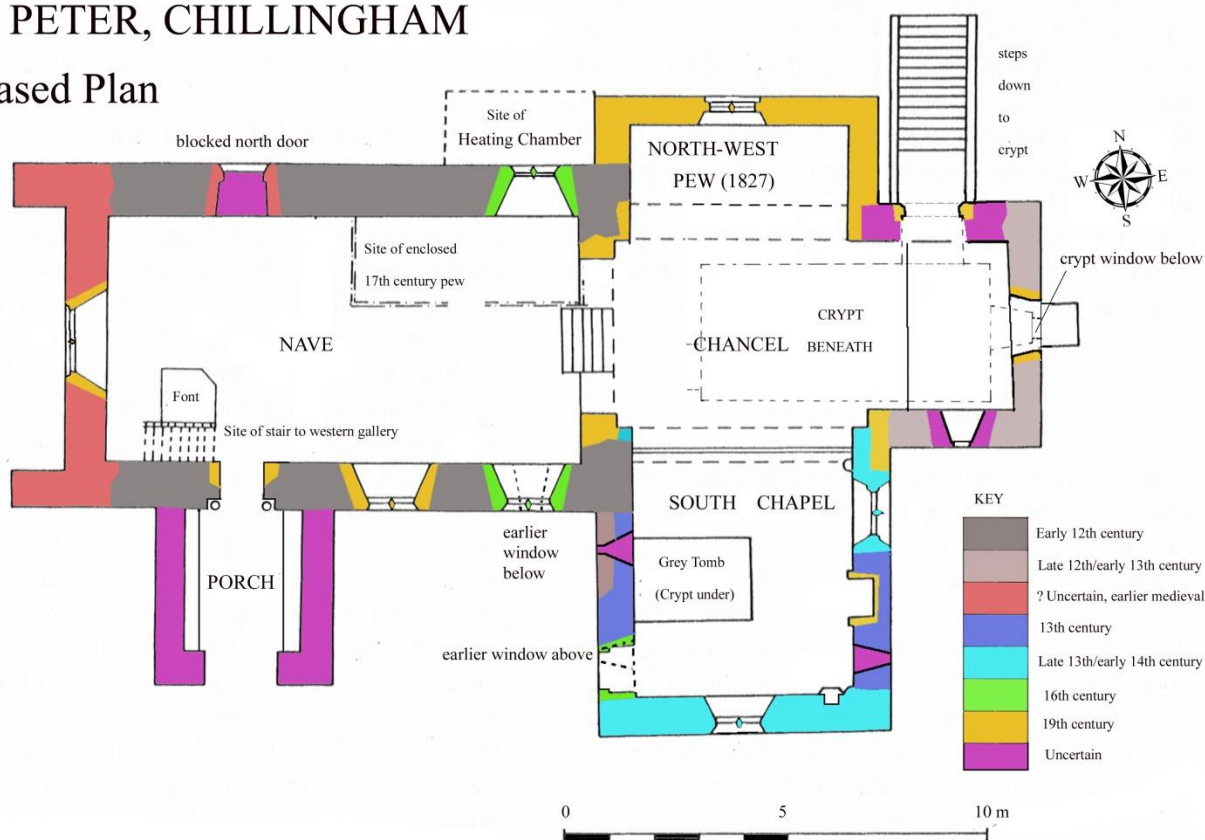

based on plan by Honeyman (1935) amended Heslop & Harbottle (1999), further amendment and phasing PFR 2019

Archaeological Assessment

The nave floor has a central paved aisle (and paved area around the font at the west end) and raised wooden platforms beneath the pews. The chancel floor is of old slabs, probably re-laid, with various sockets and evidence of fittings not easy to interpret. The sanctuary and altar platform have relatively modern paving. The floor of the South Chapel, two steps below that of the chancel, has some quite elaborate patterned paving around the tomb, but it may be no older than the 19th century. The North Pew has dark (limestone?) floor slabs, flush with the floor of the chancel, and again these look of no great age.

There is now no immediate evidence of any underfloor heating system, but the openings in the north nave wall, and the 'Stoke Hole' on Wilson's 1870 plan indicate that there once

was one, and it will certainly have disturbed sub-floor archaeological remains. Despite this evidence of earlier building phases almost certainly survives beneath the present floors, so any works that entail disturbance of underfloor deposits will at least require proper archaeological monitoring.

The walls of the church are now bare of plaster, with the fabric fully exposed. This is complex, and the story of the building is not easily read from it. Any works which disturb this fabric will again need careful monitoring, and should be preceded with detailed recording, either by photogrammetry or measured drawings.

These strictures also apply to works in the churchyard, especially any adjacent to the building. It should be borne in mind that, especially in the immediate vicinity of a church building around which accumulated ground levels may have been reduced (to reduce damp problems), articulated burials may be encountered at relatively shallow depth.

Peter F Ryder April 2019

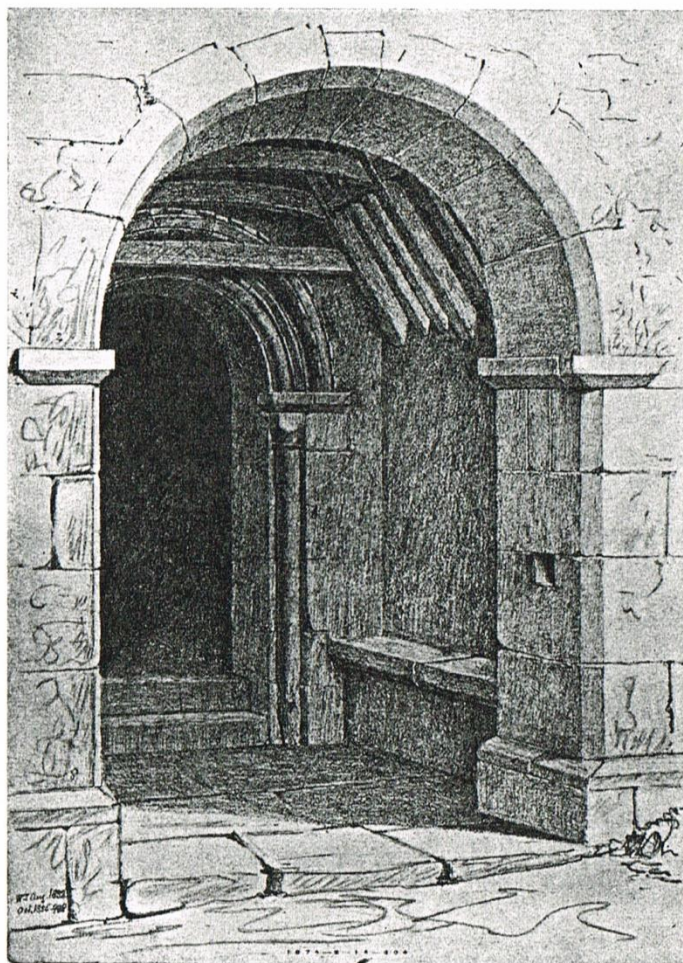

CHILLINGHAM CHURCH, SOUTH PORCH BEFORE RECONSTRUCTION,
from a pencil drawing by W. Twopenny.

ST PETER'S CHURCH CHILLINGHAM

CRYPT BENEATH CHANCEL

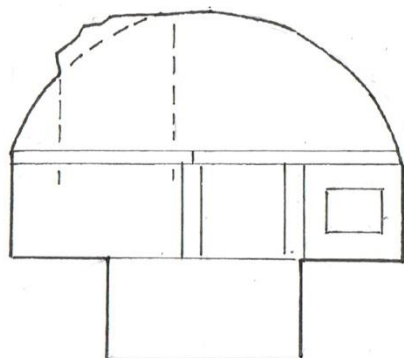

Section a-b looking west

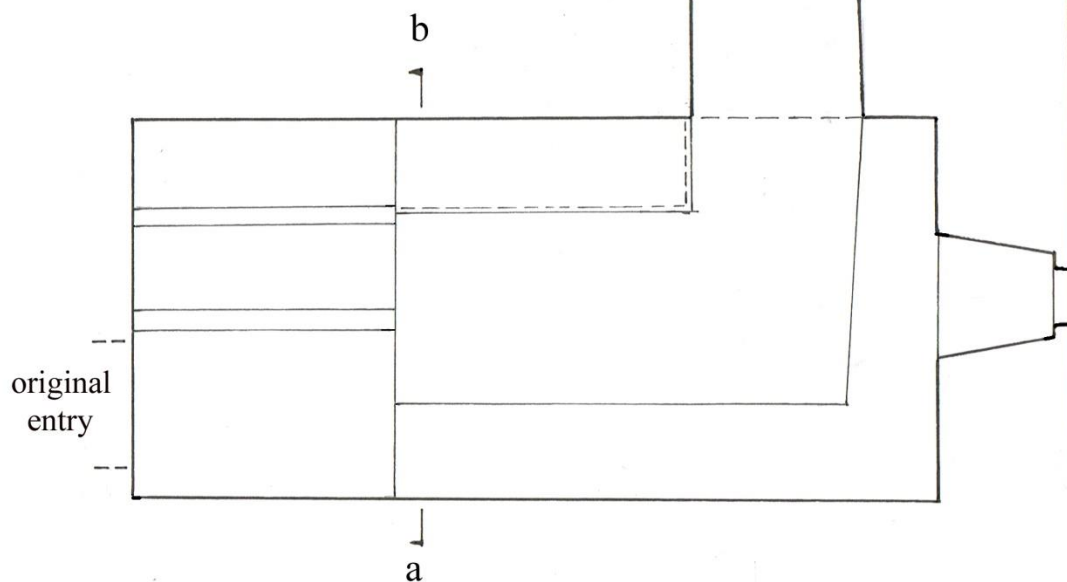

Survey P F Ryder 4 4 2019

0 1 2 3 metres

